

GRAN SPORT GROUP

pages 54-55

NUOVO GRAN SPORT GEAR - FRONT CHANGERS
WITH ALTERNATIVE GRAN SPORT CONTROL LEVERS

pages 56-57-58-59-60

NUOVO TIPO HUBS

page 61

ROAD SPORT CHAINWHEEL SET AND
BOTTOM BRACKET SET

pages 62-63

SPORT HEAD SET - FORK ENDS

page 64

2240 CAMPAGNOLO GRAN SPORT GROUP

(Particular components of this group are illustrated from page 56 to page 64)

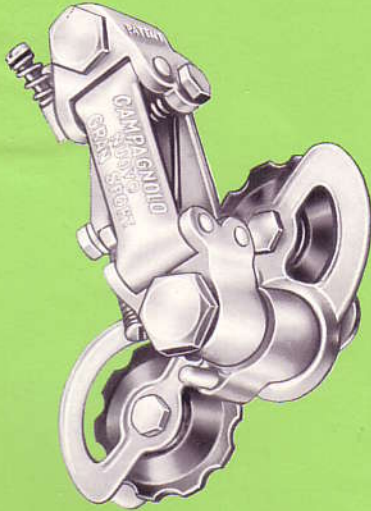

3500



2050

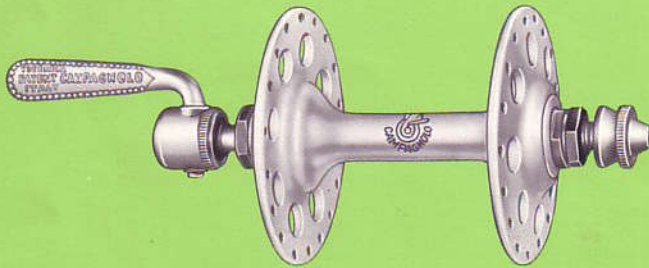

1253



- 606 Down tube control gear inner wire (118 cm.)
- 608 Down tube control front changer inner wire (72 cm.)
- 622 Gear stainless steel outer casing (21 cm.)
- 626/A Twin gear cable clip
- 636 Chainstay clip
- 1010 Set Record front and rear fork ends
- 1014/1A Gran Sport twin down tube control lever. See alternatives on pages 58-59

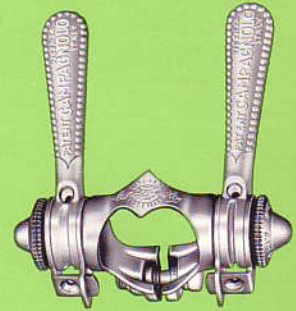

1014/1A



626/A



636

1040/A Sport head set (thread \varnothing 25,4 x 24F.). Upon request are furnished with thread \varnothing 25 x 1M. or \varnothing 1" x 24 Tpi-BSC
 1253 Pair Nuovo Tipo large flange quick release hubs (front width 100 mm., rear width 120 mm., flanges with 36 holes, thread \varnothing 35 x 24F.). Upon request furnished with thread \varnothing 34,7 x 1M. or \varnothing 1,370" x 24 Tpi-BSC. See other alternatives on page 61

2050 Front changer. See alternatives on page 60
 3320/A Sport road chainset (with cranks 170 mm., pedal hole \varnothing 9/16" x 20F. and fixed couple of chainrings for chain 1/2" x 3/32" [2 mm.]). Specify the number of teeth of the fixed couple of chainrings available as follows: 42/49T - 42/50T - 42/51T - 42/52T - 42/53T. Upon request

furnished cranks with pedal hole M.14 x 1,25
 3330/A Sport chainwheel set
 3331 Sport bottom bracket set (bracket width 70 mm. and cups threaded \varnothing 36 x 24F.). See alternatives on pages 62-63. Upon request is furnished the bracket safety sleeve ref. 2110 - 2110/1. See page 81
 3500 Nuovo Gran Sport gear (without hanger)

3330/A



3320/A



3331

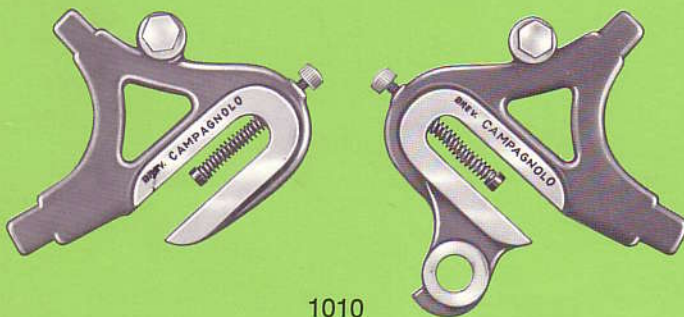

1010



1040/A

PARTICULAR COMPONENTS OF CAMPAGNOLO GRAN SPORT GROUP 2240

3500	Nuovo Gran Sport gear (without hanger)	930/B	Roller
82/A	Body ferrule	931/B	Roller bush
84	Gear return spring screw	932/A	Roller dust cover
99	Gear adjusting screw	933	Roller bolt
120	Lower adjuster spring	3501	Upper body
120/1	Upper adjuster spring	3502	Lower body
124	Fixing screw	3503	Front arm
780	Cable clamp screw washer	3504	Inner arm
808/A	Spindle	3505	Spring cage bolt
810/1A	Lower body bush	3506	Upper pivot bolt
812/1A	Grub screw	3507	Outer cage plate
813/A	Tension spring	3508	Cover
926	Inner cage plate	3509	Gear return spring

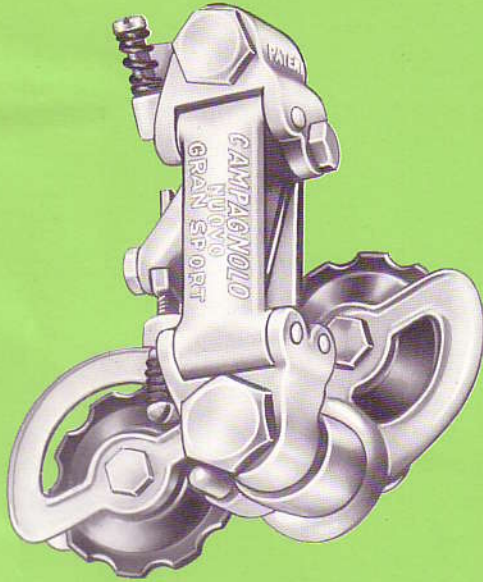

3500

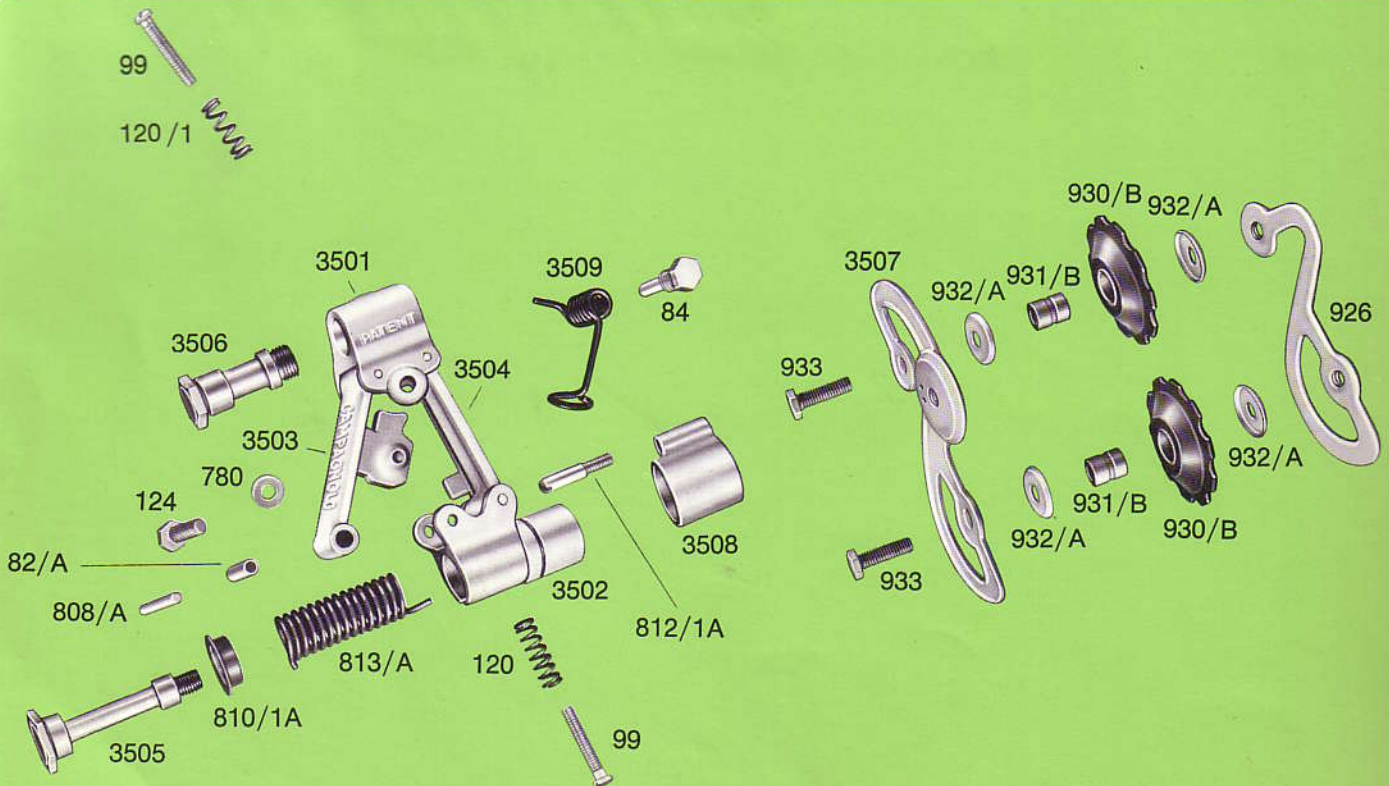

**PARTICULAR
COMPONENTS
OF CAMPAGNOLO
GRAN SPORT
GROUP
2240**

- 2050 Front changer
- 89 Clamp washer
- 210 Body clip bolt
- 211 Body fixing clip
- 213 Fork fixing bolt
- 214 Fork cage
- 217 Nut
- 226 Adjusting bolt spring
- 227 Adjusting lever screw
- 780 Cable clamp bolt washer
- 1601 Front changer body
- 1602 Control fork
- 1603 Spindle
- 1604 Front changer return spring
- 1605 Bolt

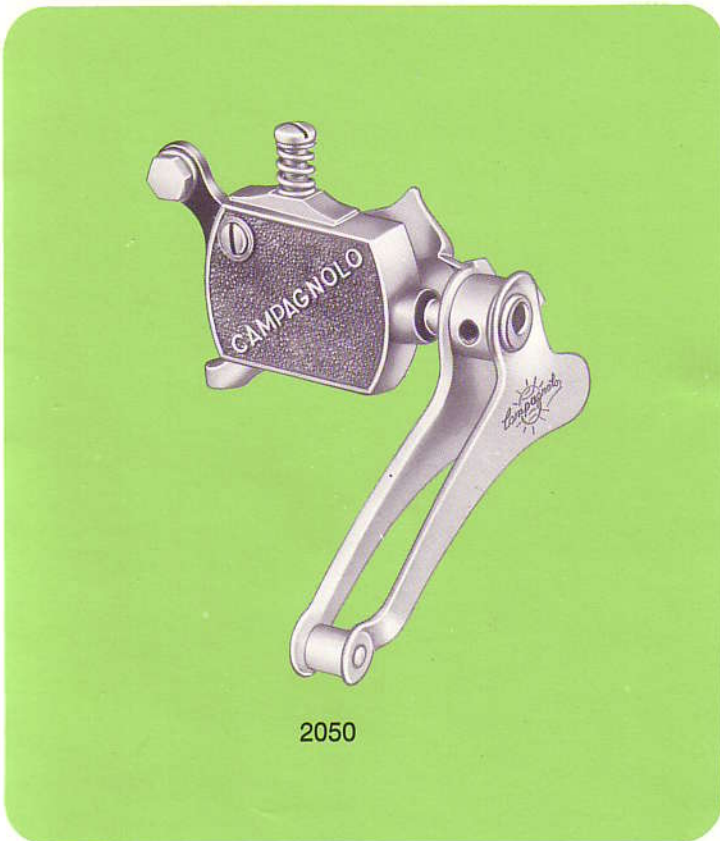

2050

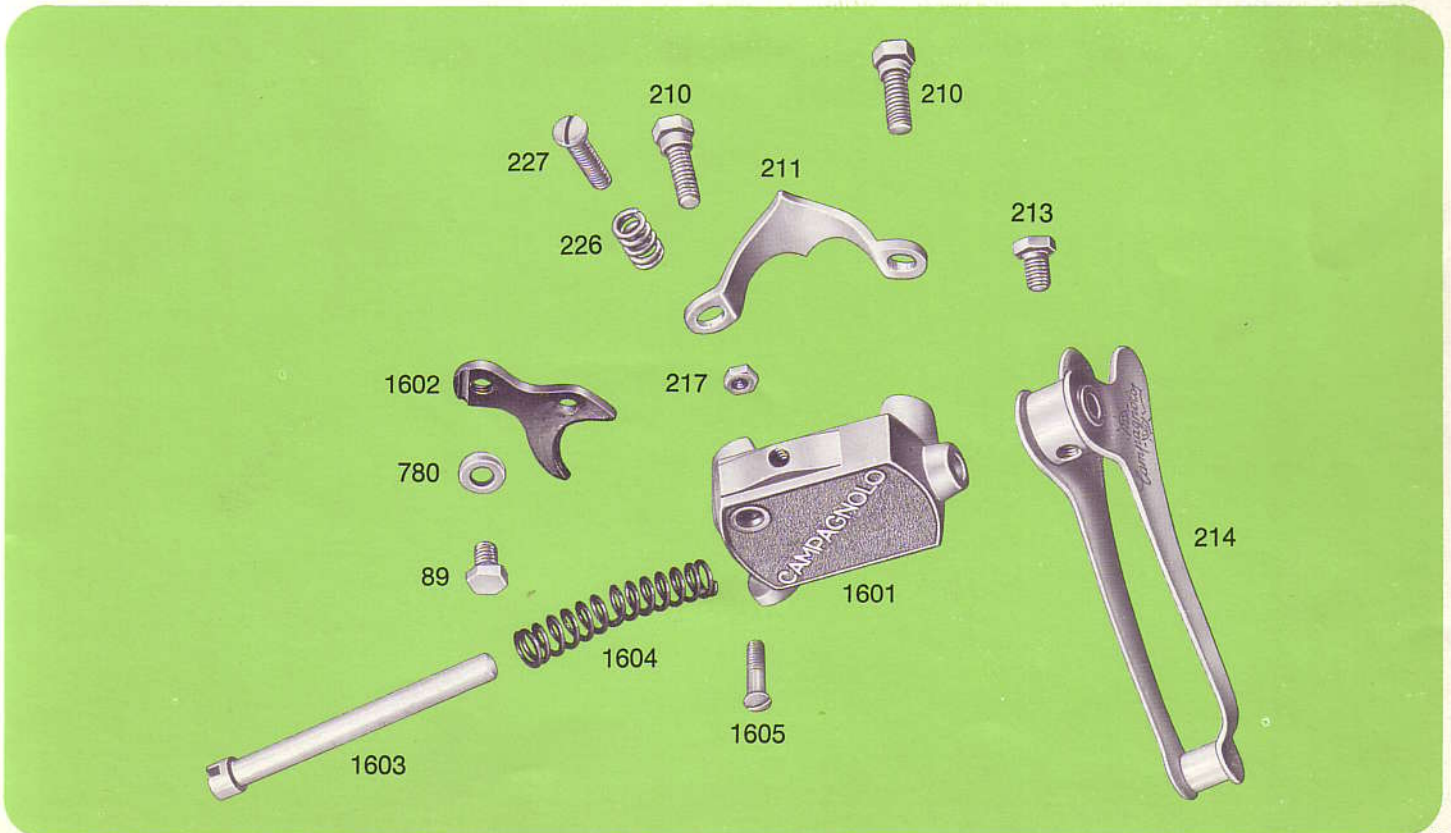

**PARTICULAR
COMPONENTS
OF CAMPAGNOLO
GRAN SPORT
GROUP
2240**

- 1013/1A Right hand Gran Sport down tube control
- 1014/1A Gran Sport twin down tube control lever
- 1207 Braze-on gear control
- 1208 Braze-on front changer control
- 174 Friction plate
- 600/3 Right hand braze-on control lever plate with ferrule
- 601 Right hand control lever only

